

The touch panel is the Smart Hotel guest system command control equipment, has a high sensitivity capacitive touch sensor IC. Provides guest room three state service input, lighting control, scene control, curtain control, temperature control. Each touch button programmable target instruction count up to 20. Has mini USB firmware upgrade port.

technical data



Touch Button Allocation

- 3 for Service Buttons
- 3 for Light Control Buttons
- 3 for Mood Control Buttons
- 3 for Curtain Control Buttons
- 3 for Climate Control Buttons

Extra features

- Each button has a dual color LED for background and working status indication
- Auto sleep to reduce the current consumption when idle
- Easy sBUS connector tech.

Control Applications

lighting, HVAC, IR, moods and scenes, hotel guest room service

Installation

- wall Mount metal frame twist
- Magnetic screw less mounting
- Advanced security locking
- Easy SBUS connector tech.

Compliance

CE Mark EMC

Total Gangs

This Touch panel is equal to 20 gangs

Control IO

1 x Advanced RS485 S-BUS serial port links (both train & screw link types)

Upgrade IO

1 x mini USB port (to connect to special programming board)

Operation Protection

- BUS Rv. Polarity Protection
- BUS Short Circuit Protection

SBUS DC Supply

24VDC with flexible tolerance between 8-32VDC. Flexible ability to add power supply as to be needed any where
Power consumption: max 50mA

Operating Environment

0° to 45°C ambient temperature
20% to 93% RH

Enclosure material

Aluminum, Glass, and poly

Dimensions & Weight

L168mm x W100mm x H14.6mm; weight:0.23kg

connection diagram

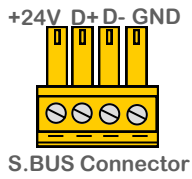
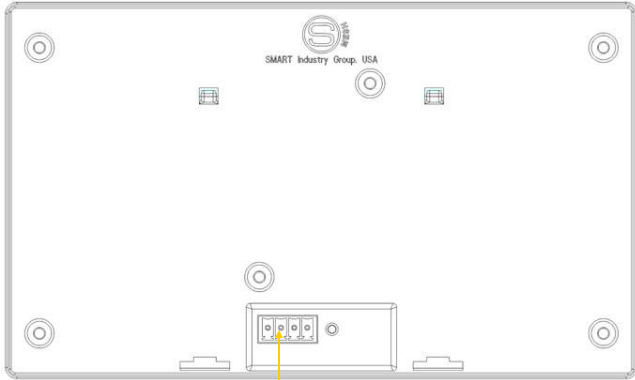

mounting dimensions

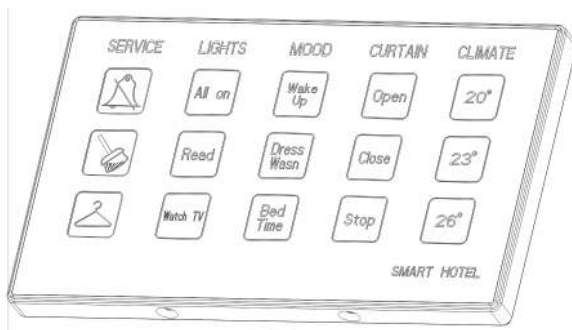
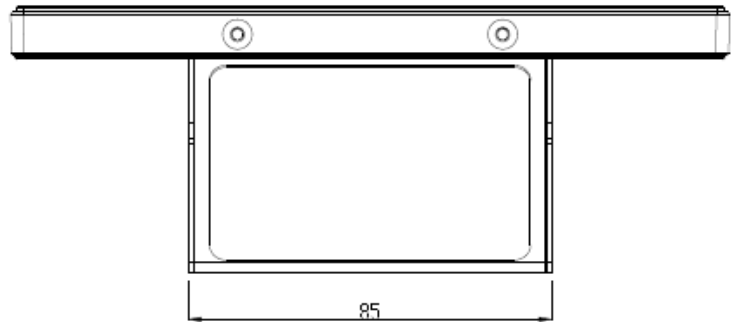
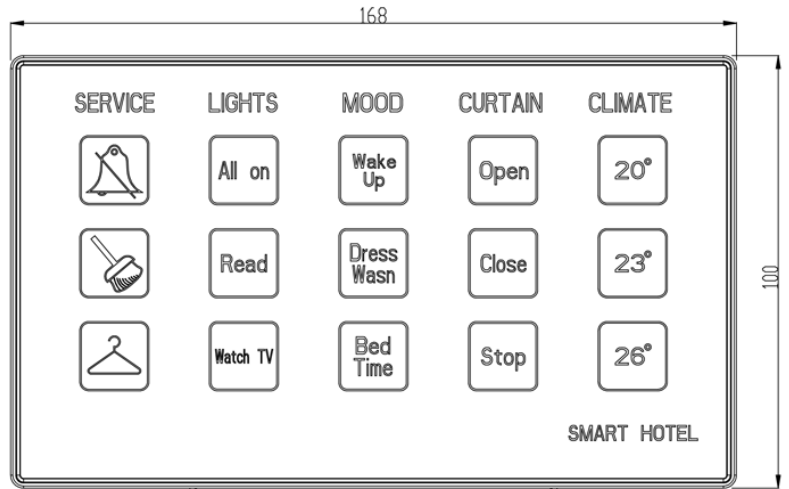

PROSPECTIVE

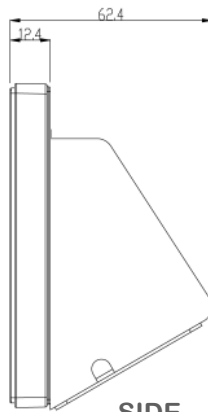

SIDE

S-BUS connection

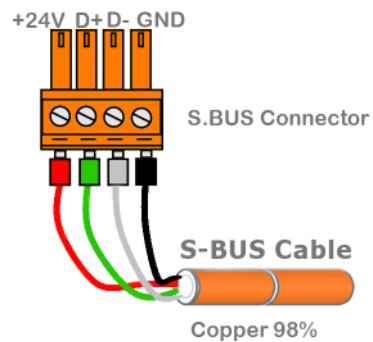

UTP core colors

S.BUS +24V		אדום
S.BUS GND		שחר
S.BUS D+		ירוק
S.BUS D-		לבן