

פנל 6 לחצנים חכם, חיווי מצבי פעולה מואר לכל לחצן, מקלט אינפרא מובנה להפעלה באמצעות שלט חכם G4, הפעלות מקומיות ו/או תרחישים. אפשרות לחיצה כפולה. כניסת מיני USB חיצוני מאפשר עדכוני תוכנה.

technical data



Added features

- Lockable keys/ buttons
- Lockable IR receiver
- Changeable fascia colors
- LED backlit buttons and LCD
- Reloadable IR receiver 15m
- Screw less mounting
- Easy sBUS connector tech.

Control Applications

- lighting, security arming, motorized shades, moods and scenes, on/off music, fountains, irrigation, gates, LED color, service request, panic, lifts, fountains, gates..etc.

User Controls

- user control buttons
- Diagnostics + BROADCAST

Button behavior

- Single click (on/Off toggle)
- Double click (mood/Macro)
- Keep press (dim/ramp)

Programming

- Manual Pairing to Lighting,
- Advanced Software Configuration & Programming

Compliance

- CE Mark EMC
- ROHs, CPT

Total Gangs

6 gangs

Control IO

1 x Advanced RS485 S-BUS serial port links (both train & screw link types)

Upgrade IO

1 x mini USB port (to connect to special programming board)

Operation Protection

- BUS Rv. Polarity Protection
- BUS Short Circuit Protection

SBUS DC Supply

24VDC with flexible tolerance between 8-32VDC. Flexible ability to add power supply as to be needed any where
Power consumption: 25mA

Installation

- wall Mount metal frame twist
- Magnetic screw less mounting
- Advanced security locking
- Easy sBUS connector tech.

Operating Environment

0° to 45°C ambient temperature
20% to 93% RH

Enclosure material

Aluminum, Glass, and poly

Dimensions & Weight

W85mm x L85mm x H12mm x D8mm. Backed weight 0.2 kg



- Lighting
- Music
- Curtains
- Moods
- Security
- Service
- Color
- Drapes
- Pumps
- Gates



GTIN (UPC-EAN): 0610696254269
Patent P. No: 201110123081.0



connection diagram

mounting dimensions

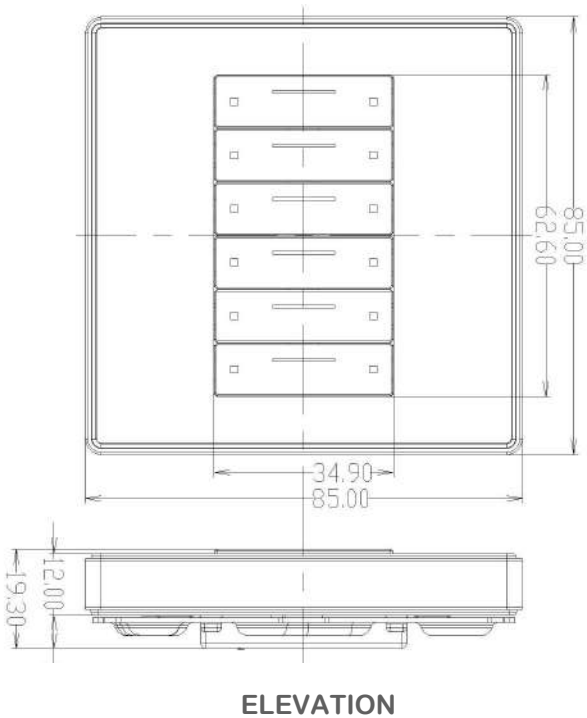
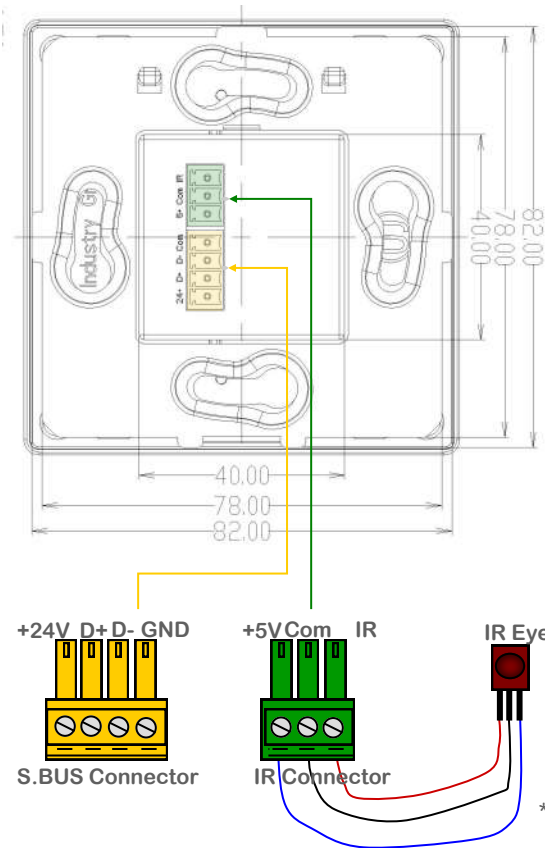

*IR Expansion Cable Tested at 15 Meters & found Perfectly operational

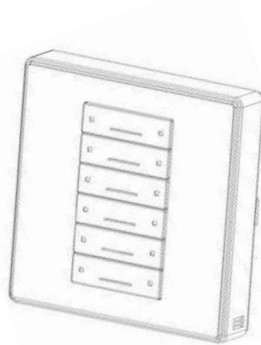

PROSPECTIVE

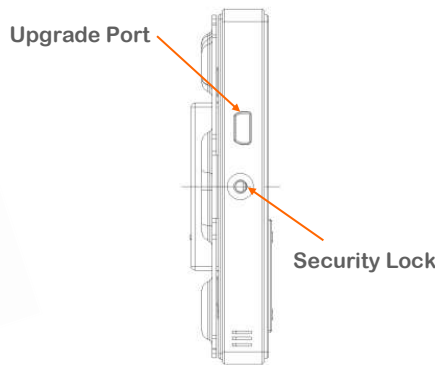

SIDE VIEW



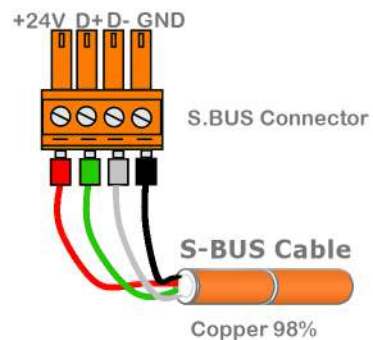





S-BUS connection



Copper 98%



UTP core colors

S.BUS +24V		כתום
S.BUS GND		כתום / לבן
S.BUS D+		כחול
S.BUS D-		כחול / לבן
Spare		ירוק
Spare		ירוק / לבן
Spare +12v		חום
Spare -12V		חום / לבן